



AS20S2SF1FA-MW3  
AS25S2SF1FA-MW3  
AS35S2SF1FA-MW3  
AS42S2SF1FA-MW3  
AS50S2SF1FA-MW3  
AS71S2SF1FA-MW3  
AS20S2SF1FA-MB3  
AS25S2SF1FA-MB3  
AS35S2SF1FA-MB3  
AS42S2SF1FA-MB3  
AS50S2SF1FA-MB3  
AS71S2SF1FA-MB3

- Please read this operation manual before using the air conditioner.  
Keep this operation manual for future reference.





Read the precautions in this manual carefully before operating the unit.



This appliance is filled with R32.

Keep this manual where the user can easily find it.

## WARNING:

- Do not use means to accelerate the defrosting process or to clean, other than those recommended by the manufacturer.
- The appliance must be stored in a room without continuously operating ignition sources (for example: open flames, an operating gas appliance or an operating electric heater).
- Do not pierce or burn.
- Be aware that refrigerants may not contain an odour.
- The appliance must be installed, operated and stored in a room with a floor area larger than 3 m<sup>2</sup>.
- If the supply cord is damaged, it must be replaced by the manufacturer, its service agent or similarly qualified persons in order to avoid a hazard.
- This appliance can be used by children aged 8 years and above and persons with reduced physical, sensory or mental capabilities or lack of experience and knowledge if they have been given supervision or instruction concerning use of the appliance in a safe way and understand the hazards involved. Children shall not play with the appliance. Cleaning and user maintenance shall not be made by children without supervision.
- The wiring method should be in line with the local wiring standard.
- All the cables shall have got the European authentication certificate. During installation, when the connecting cables break off, it must be assured that the grounding wire is the last one to be broken off. The explosion-proof breaker of the air conditioner should be all-pole switch. Distance between its two contacts should not be no less than 3mm. Such means for disconnection must be incorporated in the wiring.
- Make sure installation is done according to local wiring regulation by professional persons.
- Make sure ground connection is correct and reliable.
- A leakage explosion-proof breaker must be installed.
- Do not use a refrigerant other than the one indicated on the outdoor unit (R32) when installing, moving or repairing. Using other refrigerants may cause trouble or damage to the unit, and personal injury.



This appliance contains a UV-C lamp.

## WARNING:

- Read the maintenance instructions before opening the appliance.
- Eye or skin irritation may result from exposure from top air inlet and inner part. During air filter taking and putting for maintenance, please make sure that the power is cut off before approaching the product.
- UV-C barriers bearing the ultraviolet radiation hazard symbol should not be removed.
- Appliances that are obviously damaged must not be operated.
- Do not operate UV-C lamps outside of the appliance.
- The appliance must be disconnected from the power supply before replacing or cleaning or other maintenance of the UV-C lamp.
- The type of UV-C lamp is 0011012908.
- Front panels bearing the ultraviolet radiation hazard symbol which have UV-C radiation are provided with a hall switch to interrupt the power to the UV-C lamps for your safety. Do not over-ride hall switch by magnet and other similar material.
- Before opening front panels bearing the ultraviolet radiation hazard symbol for the conducting user maintenance, it is recommended to disconnect the power.
- If the UV-C lamp is damaged, it must be replaced by the manufacturer, its service agent or similarly qualified persons in order to avoid a hazard.
- Unintended use of the appliance or damage to the housing may result in the escape of dangerous UV-C radiation. UV-C radiation may, even in small doses, cause harm to the eyes and skin.

# Contents

PARTS AND FUNCTIONS .....	1
OPERATION .....	2
INDOOR UNIT INSTALLATION .....	11
MAINTENANCE .....	14
CAUTIONS .....	15
TROUBLE SHOOTING .....	16

# Parts and Functions

## ■ Wi-Fi function description

The system architecture diagram

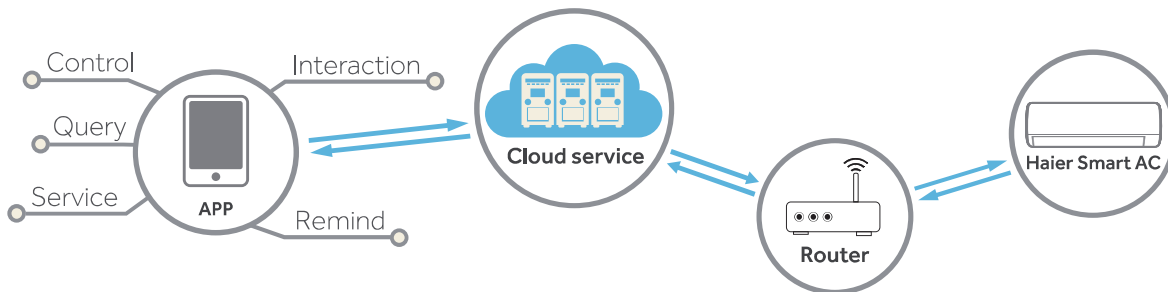

### The application environment

Smart mobile phone and wireless router are necessary for the application.  
Wireless router must be able to connect to the Internet.  
Smart mobile phone requires IOS or Android system:



IOS system  
must support IOS 9.0 or above



Android system  
must support Android 5.0 or above

### Configuration method

Scan the QR code below to download "hOn" APP.  
Other Download options: Please search hOn APP on:

- App Store (IOS)
- Google Play (Android)
- Huawei AppGallery (Android)



After App Download, please register, connect the air conditioner and enjoy using hOn to manage your device. Please refer to the HELP section inside the APP for more details about how to register, connect the unit, and other operations.

# Parts and Functions

## Indoor Unit

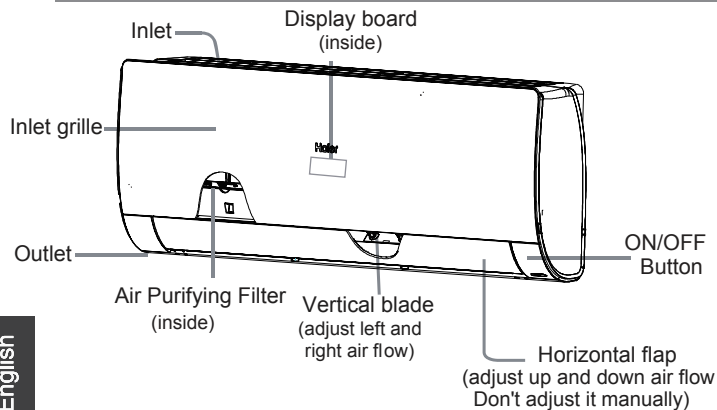

English

### Display board

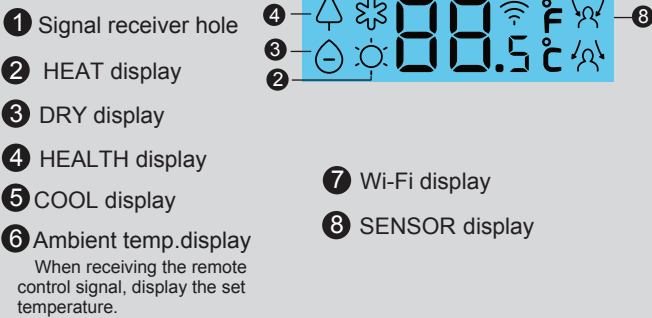

### Display board

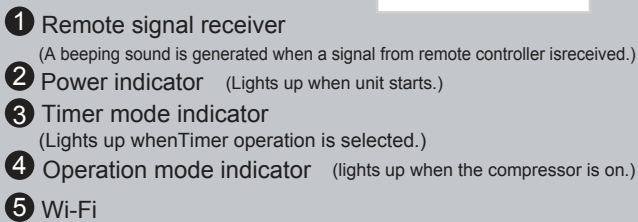

Actual inlet grille may vary from the one shown in the manual according to the product purchased

## Outdoor Unit

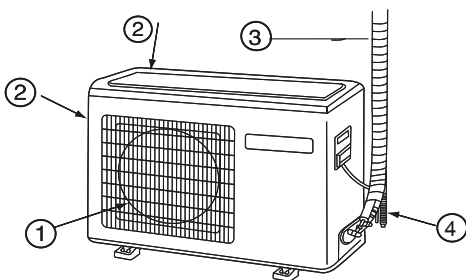

- 1 OUTLET
- 2 INLET
- 3 CONNECTING PIPING AND ELECTRICAL WIRING
- 4 DRAIN HOSE

## Remote controller

### Outer side of the controller

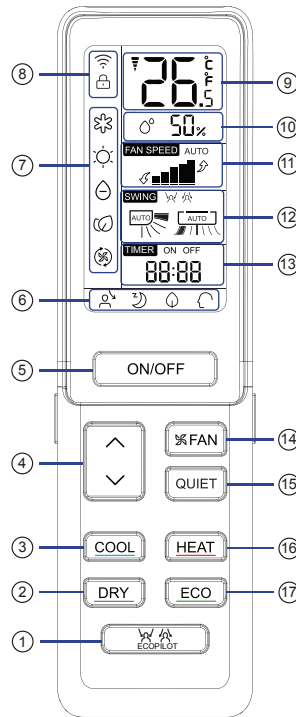

- 5. ON / OFF button
- 6. Display of each function status
- 7. Operation mode display
- 8. WIFI and CLOCK display
- 9. TEMP display
- 10. Humidity display
- 11. FAN SPEED display
- 12. SWING display  
Swing up/down display  
swing left/right display
- 13. TIMER ON display  
TIMER OFF display  
CLOCK display
- 14. FAN button
- 15. QUIET button
- 16. HEAT button
- 17. ECO button  
power saving function

- 1. ECOPILOT button
- 2. DRY button  
Used to set DRY operation.
- 3. COOL button  
Used to set COOL operation.
- 4. TEMP button  
used to change setting temperature

#### NOTE:

- a. Humidity display is unavailable on some models
- b. If the model you buy has a WIFI function, press the "ON/OFF" button for 5s to emit the WIFI binding signal. Once in the binding mode, the APP will show how to bind.

# Operation

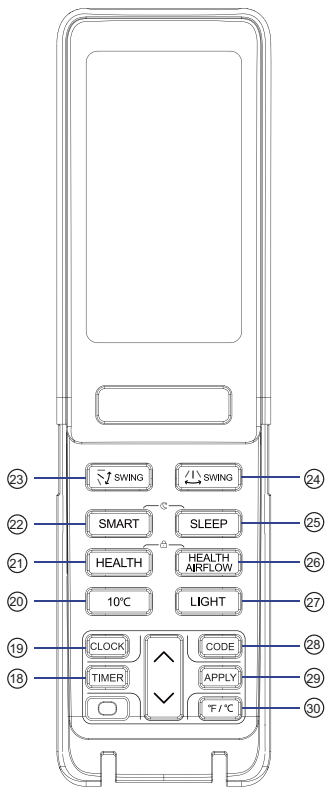

18. TIMER button
19. CLOCK button
20. 10 °C button  
special heating set function: 10 degree heating maintaining (valuable for RS)
21. HEALTH button
22. SMART button  
Used to set SMART operation. (This function is unavailable on some models.)
23. SWING up/down button
24. SWING left/right button
25. SLEEP button
26. HEALTH AIRFLOW button
27. LIGHT button  
Control the lightening and extinguishing of the indoor LED display board.
28. CODE button  
A-b yard
29. APPLY button
30. °F/°C button

## Note:

1. SMART+SLEEP When the light sensing function is enabled, the appliance will be in the mode. If the appliance detects that indoor light is weak (lower than the setting value) for several minutes, the light sensing function works automatically. If the appliance detects no movements of people for 20 minutes, during which the light is weaker than the setting value, it will enter the "SMART+SLEEP" mode automatically. The appliance will operate as per the sleep curve. (See the "SLEEP" function in Page 7).  
Conditions to exit:  
  - 1) The appliance detects that the indoor light is stronger than the setting value for 20 minutes.
  - 2) The appliance is in the 8h "SMART + SLEEP" mode.
  - 3) The "LIGHT SENSING" function is disabled.
 When any of the above conditions is met, the appliance will exit from the "SMART+SLEEP" mode. Once out of the "SMART+SLEEP" mode, the appliance will operate under the operation status initially set on the remote controller.  
 Note: 1) This function is not available in the "AIR SUPPLY" mode.  
 2) This function is not available in the "SLEEP" mode.  
 3) When it is in the "REMOTE SLEEP" mode or the "TIMER" is on, the appliance will exit from this function.  
 4) Light sources like indoor lamps and TV's LED light, and frequent movements of pets will affect this function.
2. Press "HEALTH"+"HEALTH AIRFLOW" simultaneously can set and cancel the "LOCK" function ( )

## Clock set

- 1 Press CLOCK button,
- 2 Press "+" or "-" to set correct time.
- 3 Confirm time.

Each press will increase or decrease 1min. If the button is kept pressed, time will change quickly.

After time setting is confirmed, press APPLY, "AM" and "PM" stop flashing, while clock starts working.

## Note:

The distance between the signal transmission head and the receiver hole should be within 7m without any obstacle as well. When electronic-started type fluorescent lamp or change-over wireless telephone is installed in the type fluorescent lamp or room, the receiver is apt to be disturbed in receiving the signals, so the distance to the indoor unit should be shorter.

Full display or unclear display during operation indicates the batteries have been used up. Please change batteries.

If the remote controller can't run normally during operation, please remove the batteries and reload several minutes later

## Hint:

Remove the batteries in case unit won't be in usage for a long period.

# Operation

## QUIET Operation

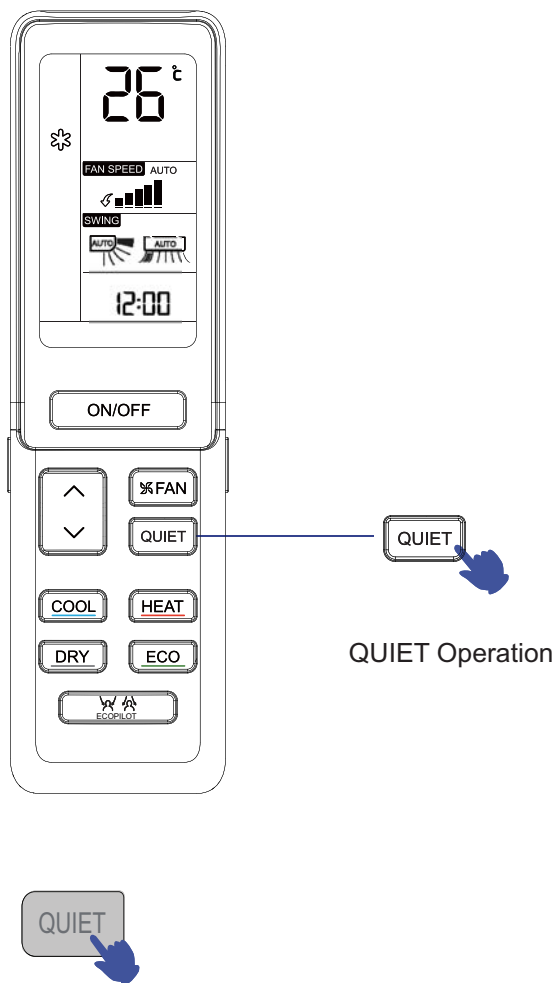

You can use this function when silence is needed for rest or reading.

For each press,  is displayed Air conditioner starts QUIET function operation. In QUIET operation mode, fan speed automatically takes low speed of AUTO fan mode.

Press QUIET button again,  disappears, the operation stops.

## COOL, HEAT and DRY Operation

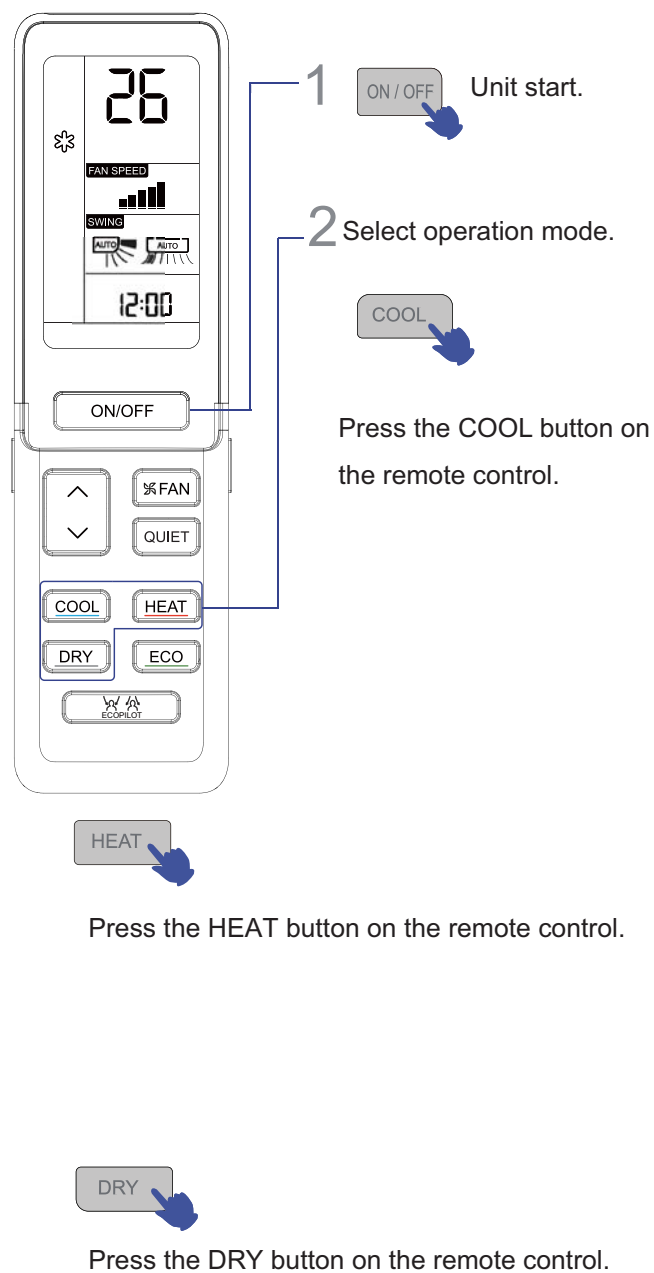

1. In DRY mode, when room temperature becomes lower than temp. setting +2 °C, unit will run intermittently at LOW speed regardless of FAN setting.
2. Remote controller can memorize each operation status. When starting it next time, just press ON/OFF button and unit will run in previous status.



# Operation

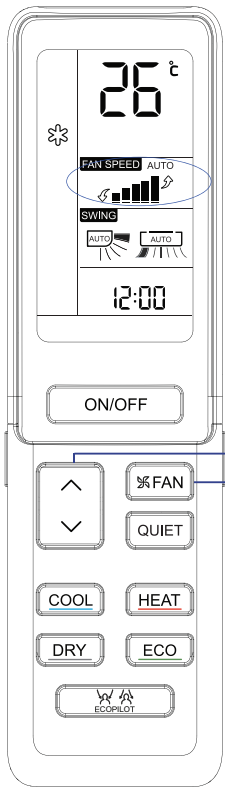

- 1 Press TEMP button.
  - △ Every time the button is pressed, temp. setting increases 0.5°C.
  - ▽ Every time the button is pressed, temp. setting decreases 0.5°C.

Unit will start running to reach the temp. setting on LCD.

## 2 FAN Operation



Press FAN SPEED button. For each press, fan speed changes as follows:



Unit will run at selected fan speed.



## 1 ECOPILOT Operation

Press ECOPILOT button. For each press, changes as follows:

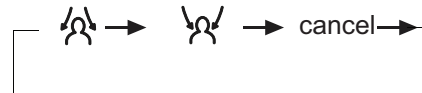

People could choose the airflow to follow or avoid their movements

## NOTE:

A human sensor is used to detect changes in the infrared radiation emitted by human bodies. In case of the following conditions, the detection may not be accurate:

- High room temperature, where the ambient temperature is close to body temperature.
- People wear a lot or lie on their stomach or back.
- People wear a lot or lie on their stomach or back.
- Frequent movements of pets, or frequent swing of curtains or other indoor objects due to the wind.
- The left and right deflectors deviate to right.
- The left and right ends of the indoor unit are installed too close to the wall.
- There is direct sunlight inside the room.

The air conditioner operates in a room where ambient temperature fluctuates sharply.

Besides, if a person is at the border of two or three air blowing areas, the following air will be sent to these two areas respectively or be swept automatically. The avoiding air will avoid these two areas or be swept automatically.

# Operation

## ECOPILOT Operation

### Human Sensing Function

1. "Follow" function: It can detect where a person is and adjust the swing flap accordingly and send air to the location of this person. If it detects people in two locations, the swing flap will blow alternatively between these two locations and stay at each location for 15s. If the appliance detects people in three or more locations, the left and right swing flaps will swing automatically.

"Avoid" function: When the appliance detects a person in a location, it will adjust the swing flap to avoid such a location. If it detects people in three or more locations, the left and right swing flaps will swing automatically.

Note:

1) When there are people in several locations or a person frequently moves between several locations, if this person is in the in-between location or the crossing location, whether the appliance is in a "Follow" mode or an "Avoid" mode, the swing flap will swing automatically to send air to these locations.

2) Whether the setting is "Follow" or "Avoid", it takes some time to adjust the air direction after the appliance identifies the location of the people and the air direction will not change immediately.

3) If the actual airflow cannot reach (or avoid) the location where a person is due to such factors as fan speed setting, temperature setting, ambient temperature difference and layout of the room, pressing the left and right swing flaps can adjust the air direction and set the airflow direction by hand.

4) Set the health airflow when the human sensing (including follow/avoid) function is enabled and exit from the human sensing (including follow/avoid) function.

5) Press the upper and lower swing flaps when the human sensing (including follow/avoid) function is enabled, there is no upper and lower full swing status.

6) When the appliance is in the upper and lower full swing status, set the human sensing function (including follow/avoid), the upper and lower swing flaps are in their standard positions of relevant mode.

2. When the human sensing function is enabled, if the appliance cannot detect people for a long time (at least 20 minutes), it will automatically enter the power saving mode. In the power saving mode, the operating frequency will lower down and the fan speed is low. Once a person is detected, the appliance will exit from the power saving mode.

3. When the human sensing function is enabled, the appliance will have a real-time detection of human movements and adjust the frequency and fan speed according to the movements. In the heating mode, if the movements are frequent, the frequency and fan speed will lower down; when the movements become less, the frequency and fan speed will rise but cannot exceed the setting values set by the remote controller. The cooling mode is contrary to the heating mode.

## HEALTH AIRFLOW Operation

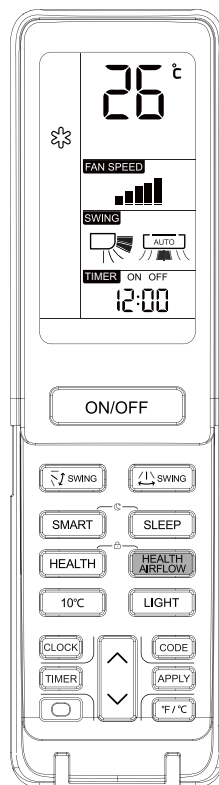

HEALTH AIRFLOW



The setting of health airflow function

1). Press the button of health airflow,  appears on the display. Avoid the strong airflow blows direct to the body.

2). Press the button of health airflow again,  appears on the display. Avoid the strong airflow blows direct to the body.

HEALTH AIRFLOW



The cancel of the health airflow function



Press the button of health airflow again, both the inlet and outlet grilles of the air conditioner are opened, and the unit goes on working under the condition before the setting of health airflow function. After stopping, the outlet grille will close automatically.

Notice:

Cannot pull direct the outlet grille by hand. Otherwise, the grille will run incorrectly. If the grille is not run correctly, stop for a minute and then start, adjusting by remote controller.

Remote controller can memorize each operation status. when starting it next time, just press ON/OFF button and unit will run in previous status.

Note:

1. After setting the health airflow function, the position of inlet and outlet grilles is fixed.
2. In heating, it is better to select the  mode.
3. In cooling, it is better to select the  mode.
4. In cooling and dry, using the air conditioner for a long time under the high air humidity, a phenomenon falling drips of water occurs at the outlet grille.
5. Select the appropriate fan direction according to the actual conditions.

# Operation

## SWING Operation

**1 Up and down air flow direction**

For each press of “ SWING” button, air flow direction on remote controller displays as follows according to different operation modes:

**COOL/DRY:**

**HEAT:**

**SMART:**

Initial state

## 2 Left and right air flow direction

For each press of “ SWING” button, remote controller displays as follows:

remote controller:

Initial state

## TIMER Operation

Set Clock correctly before starting Timer operation. You can let unit start or stop automatically a following times: Before you wake up in the morning, or get back from outside or after you fall asleep at night.

**1 Select your desired operation mode.**

Select your desired **TIMER ON**.

Remote controller: “**TIMER ON**” will flash.

Select your desired **TIMER OFF**.

Remote controller: “**TIMER OFF**” will flash.

**2 Time setting.**

Every time the button is pressed, time setting increases or decreases 1 min, if kept depressed, it will increase rapidly. It can be adjusted within 24 hours.

**3 Confirming your setting.**

APPLY

After setting correct time, press **APPLY** button to confirm “**ON**” or “**OFF**” on the remote controller stops flashing.

- When humidity is high, condensate water might occur at air outlet if all vertical louvers are adjusted to left or right.
- It is advisable not to keep horizontal flap at downward position for a long time in COOL or DRY mode, otherwise, condensate water might occur.
- As cold air flows downward in COOL mode, adjusting air flow horizontally will be much more helpful for a

To cancel **TIMER** mode  
Just press **TIMER** button several times until **TIMER** display disappear.

# Operation

## Comfortable SLEEP

Before going to bed, you can simply press the SLEEP button and unit will operate in SLEEP mode and bring you a sound sleep.

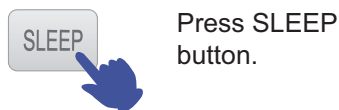
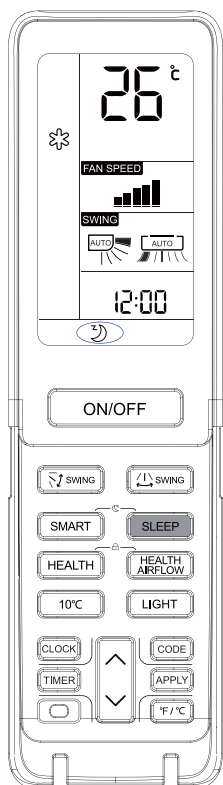

Press SLEEP button.

### Operation Mode

#### 1. In COOL, DRY mode

1 hours after SLEEP mode starts, temp. will become 1 °C higher than temp. setting. After another 1 hours, temp. rises by 1 °C further. The unit will run for further 6 hours then stops Temp. is higher than temp. setting so that room temperature won't be too low for your sleep.

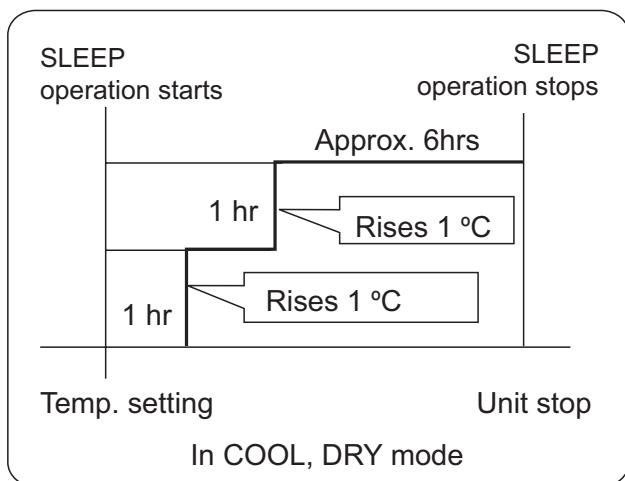

#### 2. In HEAT mode

1 hours after SLEEP mode starts, temp will become 2 °C lower than temp. setting. After another 1 hours, temp decrease by 2 °C further. After more another 3 hours, temp. rises by 1 °C further. The unit will run for further

3 hours then stops. Temp. is lower than temp. setting so that room temperature won't be too high for your sleep.

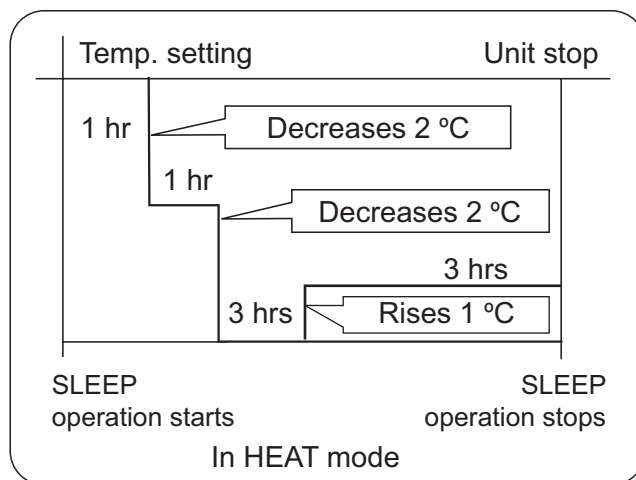

#### 3. In SMART mode

The unit operates in corresponding sleep mode, which adapted to the automatically selected operation mode.

4. When quiet sleeping function is set to 8 hours the quiet sleeping time can not be adjusted. When TIMER function is set, the quiet sleeping function can't be set up. After the sleeping function is set up, if user resets TIMER function, the sleeping function will be cancelled; the machine will be in the state of timing-on, if the two modes are set up at the same time, either of their operation time is ended first, the unit will stop automatically, and the other mode will be cancelled.

### Power Failure Resume Function

If the unit is started for the first time, the compressor will not start running unless 3 minutes have elapsed. When the power resumes after power failure, the unit will run automatically, and 3 minutes later the compressor starts running.

### Note to the power failure resume:

press the sleep button ten times in five seconds and enter function after hearing four sounds. And press the sleep button ten times within five seconds and leave this function after hearing two sounds.

# Operation

## SMART Operation

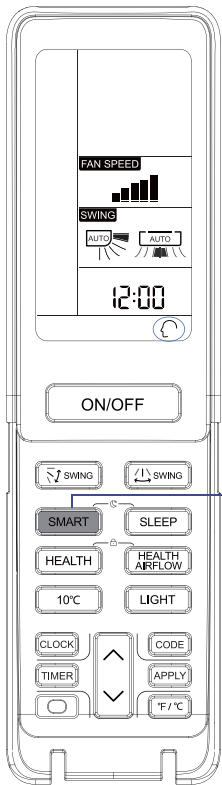

(This function is unavailable on some models)

One key can give you a comfortable room!

The air conditioning unit can judge the indoor temperature and humidity, and make the adjustment accordingly.

SMART SMART start

Press ON/OFF button, unit starts.  
Press SMART button “” is displayed on the remote controller.

- SMART FRESH
- SMART Defrost
- SMART FAN SPEED
- SMART FAN HEALTH
- SMART DRY
- SMART SOFT
- SMART Control temperature

SMART or ON/OFF SMART stops

Under the cooling, heating and dehumidifying mode, press the smart key to enter the smart function. Under the smart running mode, when the air conditioning is running, it will automatically select cooling, heating, dehumidifying or blowing mode as When the smart function is running, press the “cooling” “heating” or “dehumidifying” key to switch to the other mode, you will exit from the smart function.

## Steri Clean Operation

When the 56 °C Steri-clean function is required, please access in the hOn APP.

Introduction to Steri Clean

Stage 1 - Self Clean: to remove dirt away this function freezes the evaporator with moisture in the air, and removes dirt during the melting process. The hydrophilic aluminium coating with smaller angle ( $\alpha \approx 5^\circ$ ) helps increase water drainage efficiency.)

Stage 2 - 56 °C high temperature sterilisation: It utilizes smart temperature monitoring and frequency control technology to adjust the compressor operation, so that we maintain the evaporator temperature at high temperature for over 30mins to kill any bacteria and virus inside the air conditioner.

Stage 3 - Rapid evaporator cooling to enhance the sterilisation performance. The foil surface is coated with silver nano-particles which has an anti-bacterial efficiency up to 99%.

Attention:

- 1.The function lasts 60-80 minutes.
- 2.Hot air may come out during the process when evaporator is heated to 56 °C or maintains at 56 °C in summer.
- 3.This function may cause changes in room air temperature in winter.
- 4.When outdoor ambient temperature is above 36 °C, the function cannot be performed. Instead, Self Clean function will be turned on and lasts 21mins when Steri Clean is turned on.

# Operation

## HEALTH Operation

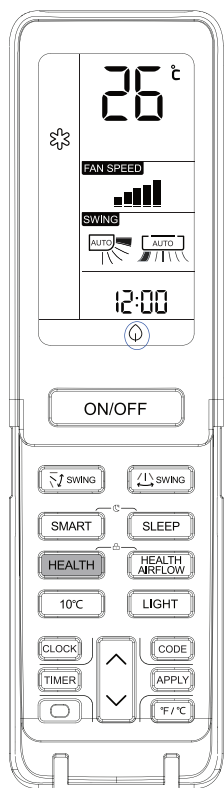

Press HEALTH button

For each press,  is displayed. Air conditioner starts health function operation.

Press HEALTH button for twice press, disappears, the operation stops.

UV sterilization function: it uses the c-band with the most effective sterilization effect in ultraviolet radiation to remove harmful microorganisms such as bacteria in the air, with remarkable effect and make the air healthy.

Attention:

1. It is recommended to turn on the UV sterilization function for 1-2 hours in one day, longer time will affect the life of the UV lamp.
2. Do not look directly at the UV lamp or touch it with your hand when the sterilizing function is on. Please turn off the sterilizing function before opening the panel.
3. Tinged blue light may appear near the air conditioning inlet when the sterilizing function is on.
4. Only when the internal fan starts and health function turned on, the UV lamp will be lighted.

## ON/OFF operation and test operation

### ON/OFF Operation:

- Use this operation only when the remote controller is defective or lost, and with function of emergency running, air conditioner can run automatically for a while.
- When the emergency operation switch is pressed, the "Pi" sound is heard once, which means the start of this operation.
- When power switch is turning on for the first time and emergency operation starts, the unit will run automatically in the following modes:

Room temperature	Designated temperature	Timer mode	Fan speed	Operation mode
Above 24 °C	24 °C	No	AUTO	COOL
Below 24 °C	24 °C	No	AUTO	HEAT

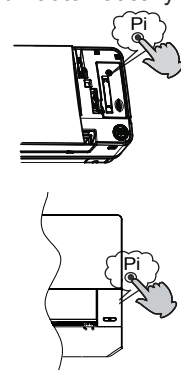

- It is impossible to change the settings of temp. and fan speed, It is also not possible to operate in timer or dry mode.

### Test operation:

Test operation switch is the same as emergency switch.

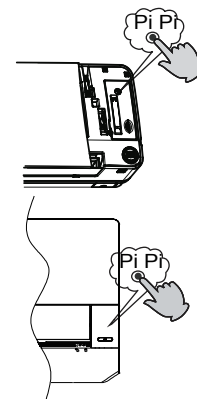

- Use this switch in the test operation when the room temperature is below 16 °C, do not use it in the normal operation.
- Continue to press the test operation switch for more than 5 seconds. After you hear the "Pi" sound twice, release your finger from the switch: the cooling operation starts with the air flow speed "Hi".



# Operation

## EUROPEAN REGULATIONS CONFORMITY FOR THE MODELS

### Loading of the battery

- 1  Remove the battery cover;
- 2  Load the batteries as illustrated. 2 R-03 batteries, resetting key (cylinder); Be sure that the loading is in line with the “+”/“-”;
- 3  Load the battery, then put on the cover again.

### IMPORTANT INFORMATION REGARDING THE REFRIGERANT USED

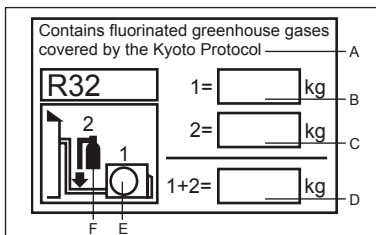

This product contains fluorinated greenhouse gases covered by the Kyoto Protocol. Do not vent into the atmosphere.

Refrigerant type:R32

GWP\* value:675

GWP=global warming potential

Please fill in with indelible ink,

- 1 the factory refrigerant charge of the product
- 2 the additional refrigerant amount charged in the field and
- 1+2 the total refrigerant charge

on the refrigerant charge label supplied with the product. The filled out label must be adhered in the proximity of the product charging port (e.g. onto the inside of the stop valve cover).

A contains fluorinated greenhouse gases covered by the Kyoto Protocol

B factory refrigerant charge of the product: see unit name plate

C additional refrigerant amount charged in the field

D total refrigerant charge

E outdoor unit

F refrigerant cylinder and manifold for charging

Climate:T1 Voltage:230V

CE

All the products are in conformity with the following European provision:

- 2014/53/EU(RED)
- 2014/517/EU(F-GAS)
- 2009/125/EC(ENERGY)
- 2010/30/EU(ENERGY)
- 2006/1907/EC(REACH)

RoHS

The products are fulfilled with the requirements in the directive 2011/65/EU of the European parliament and of council on the Restriction of the use of Certain Hazardous Substances in Electrical and Electronic Equipment (EU RoHS Directive)

WEEE

In accordance with the directive 2012/19/EU of the European parliament, herewith we inform the consumer about the disposal requirements of the electrical and electronic products.

DISPOSAL REQUIREMENTS:



Your air conditioning product is marked with this symbol. This means that electrical and electronic products shall not be mixed with unsorted household waste. Do not try to dismantle the system yourself : the dismantling of the air conditioning system, treatment of the refrigerant, of oil and of other part must be done by a qualified installer in accordance with relevant local and national legislation. Air conditioners must be treated at a specialized treatment facility for reuse, recycling and recovery. By ensuring this product is disposed of correctly, you will help to prevent potential negative consequences for the environment and human health. Please contact the installer or local authority for more information. Battery must be removed from the remote controller and disposed of separately in accordance with relevant local and national legislation.

Wi-Fi

-Wireless maximum transmit power (20dBm)

-Wireless operating frequency range (2400~2483.5MHz)

# Indoor Unit Installation

## Necessary Tools for Installation

- Driver
- Nipper
- Hacksaw
- Hole core drill
- Spanner(17,19 and 26mm)
- Gas leakage detector or soap-and-water solution
- Torque wrench (17mm,22mm,26mm)
- Pipe cutter
- Flaring tool
- Knife
- Measuring tape
- Reamer

## Power Source

- Before inserting power into receptacle, check the voltage without fail.
- The power supply is the same as the corresponding nameplate.
- Install an exclusive branch circuit of the power.
- A receptacle shall be set up in a distance where the power cable can be reached. Do not extend the cable by cutting it.

## Selection of Installation Place

- Place, robust not causing vibration, where the body can be supported sufficiently.
- Place, not affected by heat or steam generated in the vicinity, where inlet and outlet of the unit are not disturbed.
- Place, possible to drain easily, where piping can be connected with the outdoor unit.
- Place, where cold air can be spread in a room entirely.
- Place, nearby a power receptacle, with enough space around.
- Place where the distance of more than 1m from televisions, radios, wireless apparatuses and fluorescent lamps can be left.
- In the case of fixing the remote controller on a wall, place where the indoor unit can receive signals when the fluorescent lamps in the room are lightened.

## Drawing for the installation of indoor units

The models adopt HFC free refrigerant R32.

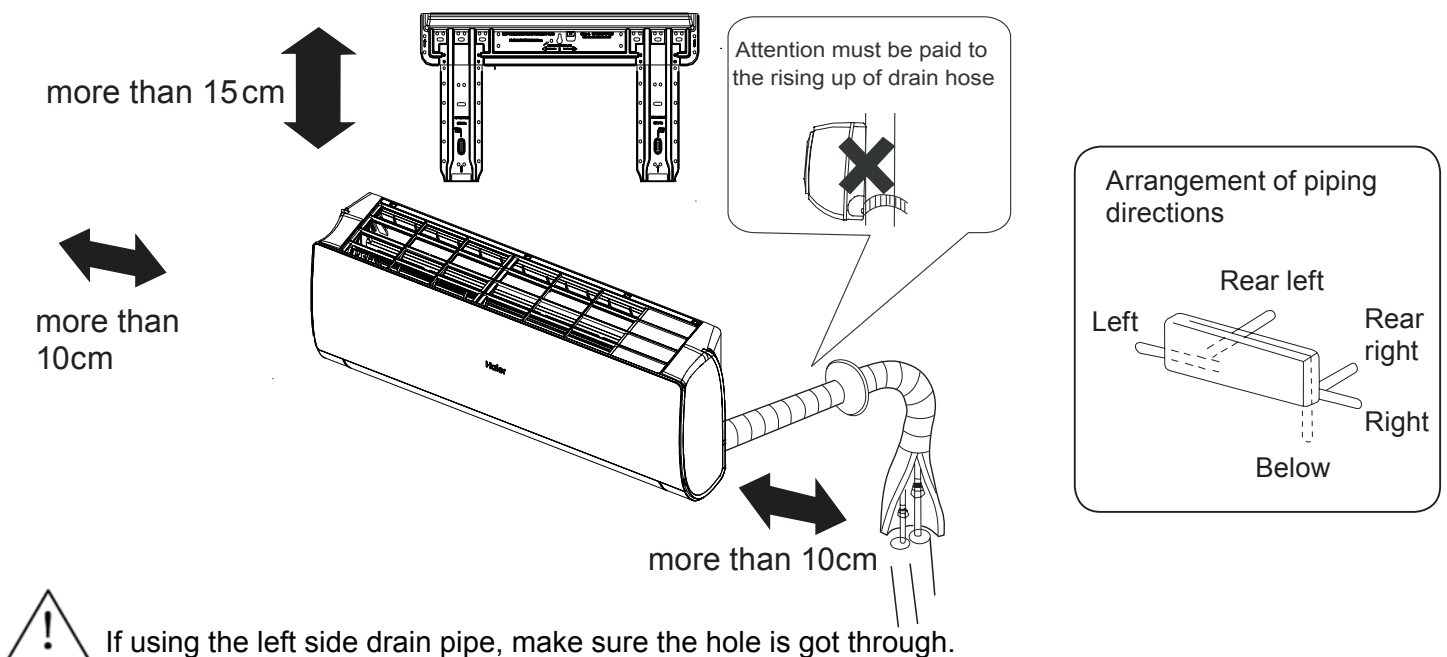

If using the left side drain pipe, make sure the hole is got through.

The distance between the indoor unit and the floor should be more than 2m.

Please be subject to the actual product purchased, the above picture is just for your reference.



# Indoor Unit Installation

## 1 Fitting of the Mounting Plate and Positioning of the wall Hole

### When the mounting plate is first fixed

1. Carry out, based on the neighboring pillars or lintels, a proper leveling for the plate to be fixed against the wall, then temporarily fasten the plate with one steel nail.
2. Make sure once more the proper level of the plate, by hanging a thread with a weight from the central top of the plate, then fasten securely the plate with the attachment steel nail.
3. Find the wall hole location A/C using a measuring tape

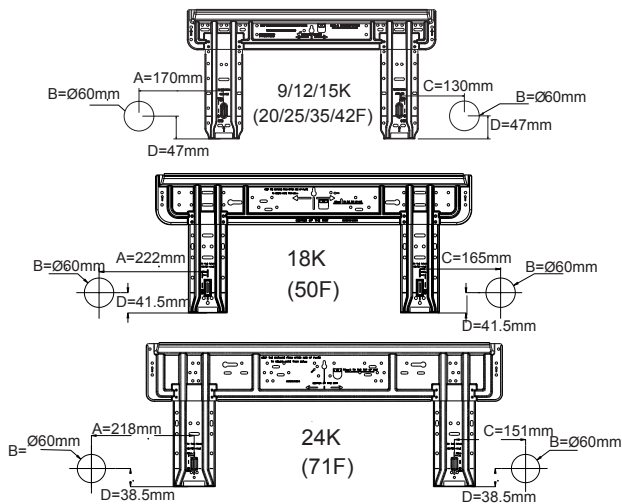

### When the mounting plate is fixed side bar and lintel

- Fix to side bar and lintel a mounting bar, which is separately sold, and then fasten the plate to the fixed mounting bar.
- Refer to the previous article, "When the mounting plate is first fixed", for the position of wall hole.

## 2 Making a Hole on the Wall and Fitting the Piping Hole Cover

- Make a hole of 60 mm in diameter, slightly descending to outside the wall
- Install piping hole cover and seal it off with putty after installation

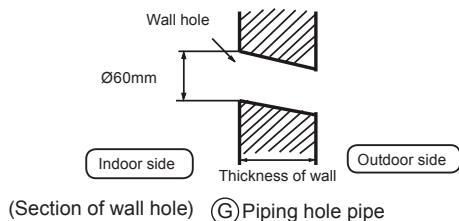

## 3 Installation of the Indoor Unit

### Drawing of pipe

#### [ Rear piping ]

- Draw pipes and the drain hose, then fasten them with the adhesive tape

#### [ Left • Left-rear piping ]

- In case of left side piping, cut away, with a nipper, the lid for left piping.
  - In case of left-rear piping, bend the pipes according to the piping direction to the mark of hole for left-rear piping which is marked on heat insulation materials.
1. Insert the drain hose into the dent of heat insulation materials of indoor unit.
  2. Insert the indoor/outdoor electric cable from backside of indoor unit, and pull it out on the front side, then connect them.
  3. Coat the flaring seal face with refrigerant oil and connect pipes. Cover the connection part with heat insulation materials closely, and make sure fixing with adhesive tape

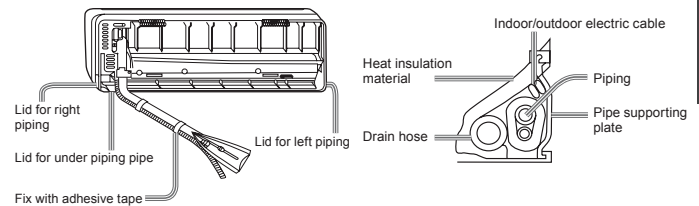

- Indoor/outdoor electric cable and drain hose must be bound with refrigerant piping by protecting tape.

#### [ Other direction piping ]

- Cut away, with a nipper, the lid for piping according to the piping direction and then bend the pipe according to the position of wall hole. When bending, be careful not to crash pipes.
- Connect beforehand the indoor/outdoor electric cable, and then pull out the connected to the heat insulation of connecting part specially.

### Fixing the indoor unit body

- Hang surely the unit body onto the upper notches of the mounting plate. Move the body from side to side to verify its secure fixing.
- In order to fix the body onto the mounting plate, hold up the body aslant from the underside and then put it down perpendicularly. mounting plate

### Unloading of indoor unit body

- When you unload the indoor unit, please use your hand to arise the body to leave a agraffe, then lift the bottom of the body outward slightly and lift the unit aslant until it leaves the mounting plate.

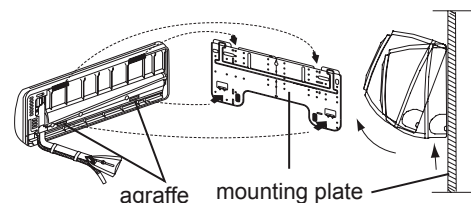

## 4 Connecting the indoor/outdoor Electric Cable

### Removing the wiring cover

- Remove terminal cover at right bottom corner of indoor unit, then take off wiring cover by removing its screws.

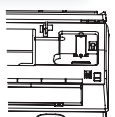

## When connecting the cable after installing the indoor unit

1. Insert from outside the room cable into left side of the wall hole, in which the pipe has already existed.
2. Pull out the cable on the front side, and connect the cable making a loop.

## When connecting the cable before installing the indoor unit

- Insert the cable from the back side of the unit, then pull it out on the front side.
- Loosen the screws and insert the cable ends fully into terminal block, then tighten the screws.
- Pull the cable slightly to make sure the cables have been properly inserted and tightened.
- After the cable connection, never fail to fasten the connected cable with the wiring cover.

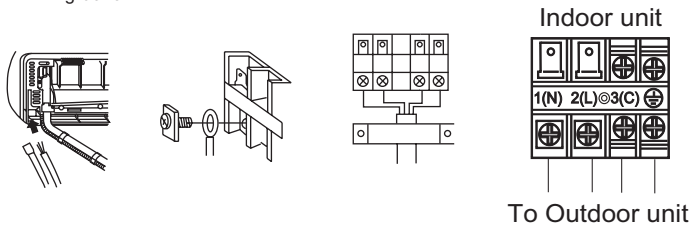

### Note:

When connecting the cable, confirm the terminal number of indoor and outdoor units carefully. If wiring is not correct, proper operation can not be carried out and will cause defect.

Connecting wiring	4G1.0mm <sup>2</sup>
-------------------	----------------------

1. If the supply cord is damaged, it must be replaced by the manufacturer or its service agent or a similar qualified person. The type of connecting wire is H05RN-F or H07RN-F.
2. If the fuse on PC board is broken please change it with the type of T.3.15A/250VAC (Indoor).
3. The wiring method should be in line with the local wiring standard.
4. After installation, the power plug should be easily reached.
5. A breaker should be incorporated into fixed wiring. The breaker should be all-pole switch and the distance between its two contacts should be not less than 3mm.

## 5 Power Source Installation

- The power source must be exclusively used for air conditioner.
- In the case of installing an air conditioner in a moist place, please install an earth leakage breaker.
- For installation in other places, use a circuit breaker as far as possible.

## 6 Cutting and Flaring Work of Piping

- Pipe cutting is carried out with a pipe cutter and burs must be removed.
- After inserting the flare nut, flaring work is carried out.

	Flare tool for R410A	Conventional flare tool	
	Clutch-type	clutch-type(Rigid-type)	Wing-nut type (Imperial-type)
A	0~0.5mm	1.0~1.5mm	1.5~2.0mm

### Flare tooling die

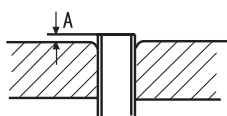

### 1. Cut pipe

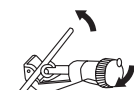

### 2. Remove burs



### 3. Insert the flare nut

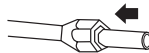

### 4. Flare pipe

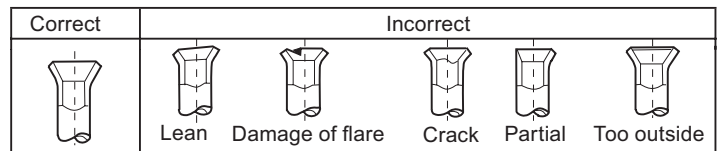
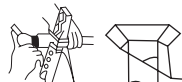

## 7 On Drainage

- Please install the drain hose so as to be downward slope without fail.
- Please don't do the drainage as shown below.

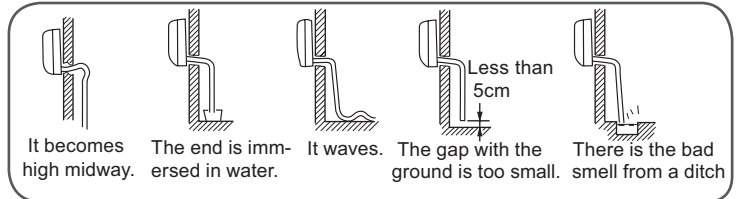

- Please pour water in the drain pan of the indoor unit, and confirm that drainage is carried out surely to outdoor.
- In case that the attached drain hose is in a room, please apply heat insulation to it without fail.

## 8 On Drainage

Code indication	Trouble description	Analyze and diagnose
E1	Room temperature sensor failure	Faulty connector connection; Faulty thermistor; Faulty PCB;
E2	Heat-exchange sensor failure	
E4	Indoor EEPROM error	Faulty EEPROM data; Faulty EEPROM; Faulty PCB;
E7	Communication fault between indoor and outdoor units	Indoor unit- outdoor unit signal transmission error due to wiring error; Faulty PCB;
E14	Indoor fan motor malfunction	Operation halt due to breaking of wire inside the fan motor; Operation halt due to breaking of the fan motor lead wires; Detection error due to faulty indoor unit PCB;

## 9 Check for Installation and Test Run

- Please kindly explain to our customers how to operate through the instruction manual.







### Check Items for Test Run

Put check mark ✓ in boxes

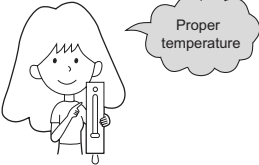
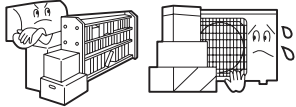
- Gas leak from pipe connecting?
- Heat insulation of pipe connecting?
- Are the connecting wirings of indoor and outdoor firmly inserted to the terminal block?
- Is the connecting wiring of indoor and outdoor firmly fixed?
- Is drainage securely carried out?
- Is the earth line securely connected?
- Is the indoor unit securely fixed?
- Is power source voltage abided by the code?
- Is there any noise?
- Is the lamp normally lighting?
- Are cooling and heating (when in heat pump) performed normally?
- Is the operation of room temperature regulator normal?

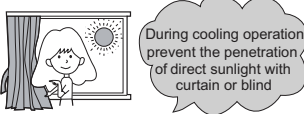
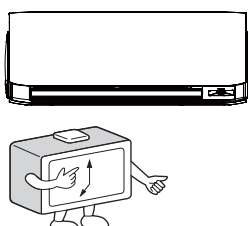
# Maintenance

## For Smart Use of The Air Conditioner

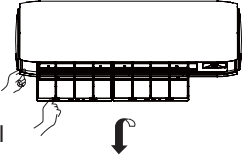
<p><b>Setting of proper room temperature</b></p> 	<p><b>Do not block the air inlet or outlet</b></p> 	<p><b>Remote Controller</b></p>  <p>Do not use water, wipe the controller with a dry cloth. Do not use glass cleaner or chemical cloth.</p>	<p><b>Indoor Body</b></p>  <p>wipe the air conditioner by using a soft and dry cloth. For serious stains, use a neutral detergent diluted with water. Wring the water out of the cloth before wiping, then wipe off the detergent completely.</p>
<p><b>Close doors and windows during operation</b></p> 	<p><b>Use the timer effectively</b></p> 	<p><b>Do not use the following for cleaning</b></p>  <p>Gasoline, benzene, thinner or cleanser may damage the coating of the unit. Hot water over 40°C (104°F) may cause discoloring or deformation.</p>	
<p><b>If the unit is not to be used for a long time, turn off the power supply main switch.</b></p> 	<p><b>Use the louvers effectively</b></p> 	<p><b>Air Filter cleaning</b></p> <ol style="list-style-type: none"> <li>1 Press the "SMART" button for 5s to partially raise the panel.</li> <li>2 Open the panel by hand and support the panel with a holder</li> <li>3 Remove the filter</li> <li>4 Clean the filter</li> <li>5 Fit the filter</li> <li>6 Remove the holder and close the panel</li> <li>7 Long press the "SMART" button and the panel will automatically lower down and become closed</li> </ol>  <p>Once every two weeks</p>	

## Replacement of Air Purifying Filter

### 1. Open the Inlet Grille

Press the "SMART" button for 5s to partially raise the panel.



### 2. Detach the standard air filter

Slide the knob slightly upward to release the filter, then withdraw it.

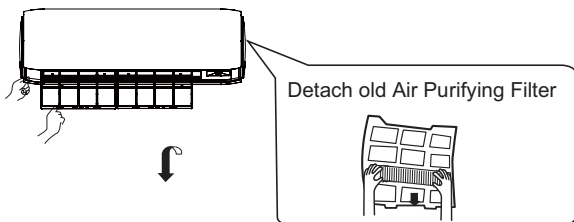

### 3. Attach Air Purifying Filter

Put air purifying filter appliances into the right and left filter frames.



### 4. Attach the standard air filter

(Necessary installation)

#### ATTENTION:

The white side of the photocatalyst air purifying filter face outside, and the black side face the unit. The green side of the bacteria-killing medium air purifying filter face outside, and the white side face the unit.

### 5. Close the Inlet Grille

Long press the "SMART" button and the panel will automatically lower down and become closed.

#### NOTE:

- The photocatalyst air purifying filter will be solarized in fixed time. In normal family, it will be solarized every 6 months.
- The bacteria-killing medium air purifying filter will be used for a long time, no need for replacement. But in the period of using them, you should remove the dust frequently by using vacuum cleaner or flapping them lightly, otherwise, its performance will be affected.
- Please keep the bacteria-killing medium air purifying filter in the cool and dry conditions avoid long time directly sunshine when you stop using it, or its ability of sterilization will be reduced.

# Cautions

## ⚠ WARNING

Please call Sales/Service Shop for the Installation.

Do not attempt to install the air conditioner by yourself because improper works may cause electric shock, fire, water leakage.

## ⚠ WARNING

When abnormality such as burnt-smell found, immediately stop the operation button and contact sales shop.

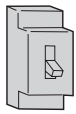

OFF



**!**  
STRICT  
ENFORCEMENT

Use an exclusive power source with a circuit breaker

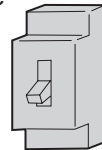

Check proper installation of the drainage securely



STRICT  
ENFORCEMENT

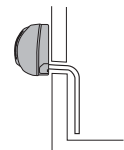

Connect power supply cord to the outlet completely



STRICT  
ENFORCEMENT

Use the proper voltage



STRICT  
ENFORCEMENT

1. Do not use power supply cord extended or connected in halfway  
2. Do not install in the place where there is any possibility of inflammable gas leakage around the unit.  
3. Do not get the unit exposed to vapor or oil steam.



PROHIBITION

Do not use power supply cord in a bundle.

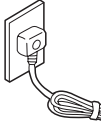

PROHIBITION

Take care not to damage the power supply cord.



PROHIBITION

Do not insert objects into the air inlet or outlet.

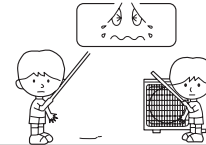

PROHIBITION

Do not start or stop the operation by disconnecting the power supply cord and so on.



PROHIBITION

Do not channel the air flow directly at people, especially at infants or the aged.



PROHIBITION

Do not try to repair or reconstruct by yourself.

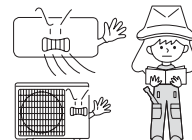

Connect the earth cable.

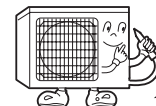

earthing

## ⚠ CAUTION

Do not use for the purpose of storage of food, art work, precise equipment, breeding, or cultivation.

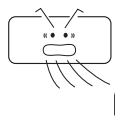

PROHIBITION

Take fresh air occasionally especially when gas appliance is running at the same time.

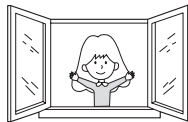

STRICT  
ENFORCEMENT

Do not operate the switch with wet hand.

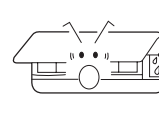

PROHIBITION

Do not install the unit near a fireplace or other heating apparatus.

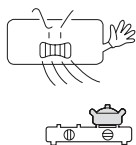

PROHIBITION

Check good condition of the installation stand

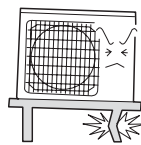

PROHIBITION

Do not pour water onto the unit for cleaning

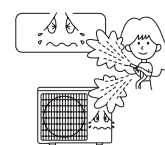

PROHIBITION

Do not place animals or plants in the direct path of the air flow

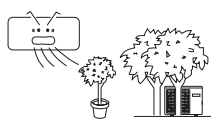

PROHIBITION

Do not place any objects on or climb on the unit.

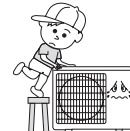

PROHIBITION

Do not place flower vase or water containers on the top of the unit.





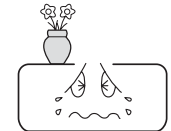

PROHIBITION



# Trouble shooting

Before asking for service, check the following first.

	Phenomenon	Cause or check points
Normal Performance inspection	The system does not restart immediately. 	<ul style="list-style-type: none"> <li>When unit is stopped, it won't restart immediately until 3 minutes have elapsed to protect the system.</li> <li>When the electric plug is pulled out and reinserted, the protection circuit will work for 3 minutes to protect the air conditioner.</li> </ul>
	Noise is heard 	<ul style="list-style-type: none"> <li>During unit operation or at stop, a swishing or gurgling noise may be heard. At first 2-3 minutes after unit start, this noise is more noticeable. (This noise is generated by refrigerant flowing in the system.)</li> <li>During unit operation, a cracking noise may be heard. This noise is generated by the casing expanding or shrinking because of temperature changes.</li> <li>Should there be a big noise from air flow in unit operation, air filter may be too dirty.</li> </ul>
	Smells are generated.	<ul style="list-style-type: none"> <li>This is because the system circulates smells from the interior air such as the smell of furniture, paint, cigarettes.</li> </ul>
	Mist or steam are blown out. 	<ul style="list-style-type: none"> <li>During COOL or DRY operation, indoor unit may blow out mist. This is due to the sudden cooling of indoor air.</li> </ul>
	In dry mode, fan speed can't be changed.	<ul style="list-style-type: none"> <li>In DRY mode, when room temperature becomes lower than temp. setting+2 °C, unit will run intermittently at LOW speed regardless of FAN setting.</li> </ul>
Multiple check		<ul style="list-style-type: none"> <li>Is power plug inserted?</li> <li>Is there a power failure?</li> <li>Is fuse blownout?</li> </ul>
	Poor cooling 	<ul style="list-style-type: none"> <li>Is the air filter dirty? Normally it should be cleaned every 15 days.</li> <li>Are there any obstacles before inlet and outlet?</li> <li>Is temperature set correctly?</li> <li>Are there some doors or windows left open?</li> <li>Is there any direct sunlight through the window during the cooling operation?(Use curtain)</li> <li>Are there too much heat sources or too many people in the room during cooling operation?</li> </ul>

# Cautions

- Do not obstruct or cover the ventilation grille of the air conditioner. Do not put fingers or any other things into the inlet/outlet and swing louver.
- This appliance is not intended for use by persons (including children) with reduced physical, sensory or mental capabilities or lack of experience and knowledge, unless they have been given supervision or instruction concerning use of appliance by person responsible for their safety. Children should be supervised to ensure that they do not play with the appliance.

## Specifications

- The refrigerating circuit is leak-proof.

The machine is adaptive in following situation

1. Applicable ambient temperature range:

Cooling	Indoor	Maximum: D.B/W.B 35°C/24°C Minimum: D.B/W.B 21°C/15°C
	Outdoor	Maximum: D.B/W.B 43°C/26°C Minimum: D.B -20°C
Heating	Indoor	Maximum: D.B 27°C Minimum: D.B 10°C
	Outdoor	Maximum: D.B/W.B 24°C/18°C Minimum: D.B -15°C
	Outdoor (INVERTER)	Maximum: D.B/W.B 24°C/18°C Minimum: D.B -20°C

- If the power supply cord is damaged, it must be replaced by the manufacturer or its service agent or a similar qualified person.
- If the fuse of indoor unit on PC board is broken, please change it with the type of T. 3.15A/ 250V. If the fuse of outdoor unit is broken, change it with the type of T.25A/250V
- The wiring method should be in line with the local wiring standard.
- After installation, the power plug should be easily reached.
- The waste battery should be disposed properly.
- The appliance is not intended for use by young children or infirm persons without supervision.
- Young children should be supervised to ensure that they do not play with the appliance.
- Please employ the proper power plug, which fit into the power supply cord.
- The power plug and connecting cable must have acquired the local attestation.
- In order to protect the units, please turn off the A/C first, and at least 30 seconds later, cutting off the power.

## Haier

Address: No. 1 Haier Road, Hi-tech Zone, Qingdao 266101 P.R. China

Contacts: TEL +86-532-8893-7937

Website: [www.haierhvac.eu](http://www.haierhvac.eu)